

Never Compromise. Always Innovate.

## Quality Comes to Light

Kingspan Light + Air | CPI Daylighting is an award-winning innovator of translucent daylighting solutions for high-performance building envelopes headquartered just north of Chicago.

Since the 1980s, we have been a pioneer and leader of the daylighting industry. We continually innovate so clients never have to choose between efficiency, style, and safety, and our pledge to sustainability is instilled at every level of the company and at every step in the manufacturing process.

Our global team of highly-skilled and experienced professionals is a community of doers, ensuring we are the partner of choice for the ever changing world of modern construction. Together, we leverage our knowledge and expertise to serve as the leading daylighting consultants for the architectural community and building industry.

Never Compromise. Always Innovate. Kingspan Light + Air.



▲ Project: AVCRAD Facility  
ID: 29452  
Location: Springfield, MO  
Architect: Jacobs



▲ Project: Hologic, Inc.  
ID: 34563  
Location: San Diego, CA  
Architect: Smith Group  
Consulting



▲ Project: UNF Student Center  
ID: 24863  
Location: Jacksonville, FL  
Architect: Rink Design Partnership



## The KLA Difference

We believe that good design can have a profoundly positive effect on the built environment, and improve the way that we work, learn, play, and live.

Our mission is to set new, higher standards for the quality and versatility of daylighting technology, as we strive to advance daylighting design.

▲ Project: Maryland Heights Community Center  
ID: 39535  
Location: Maryland Heights, MO  
Architect: CannonDesign

---

## Collaboration is Key

As expert problem-solvers, we team up with architects and designers to develop solutions that will enhance and optimize the role that natural light plays in the design of buildings. We are here to assist you through each step of the process –from preliminary design to the final installation of the system.

## Don't Compromise

As a designer, you shouldn't have to compromise your design due to product limitations or the rigidity of some manufacturers. Our goal is to enable architects to achieve the highest levels of building performance without sacrificing the aesthetic quality of their design. This is why we have worked tirelessly to develop the most versatile daylighting system on the market.

## Challenge Us

We offer architects the unique opportunity to redefine daylighting. Be creative, and explore new ways to utilize our technology. Push the envelope with your designs, and inspire others to do the same.

We were founded on innovation, but it is your imagination that continues to drive our evolution. So, what's your next bright idea?



## Our Innovative Technology

▲ Project: Grandview Heights Aquatic Centre  
ID: 36690  
Location: Surrey, B.C.  
Architect: HCMA Architecture + Design

### Two-Panel System

Our system is designed with two independent glazing panels that are mechanically connected to an internal support structure. A key feature of this design is the internal cavity between the two glazing panels. The cavity can be filled with various inserts to customize the performance of the system based on the building's requirements. Rather than sourcing a different system for each type of daylighting application, utilize a single, trusted system that is designed to adapt to meet your building performance needs.

Our translucent daylighting system delivers outstanding performance, offering the best ratio of light transmission to insulation value in the industry, and is the ultimate in design freedom and flexibility.



### Removable Skin Technology (RST)

The system is designed so that the interior and exterior glazing panels are independent of one another. Once installed, the interior panels remain intact, and each of the exterior panels can be disengaged and removed without compromising the integrity of the building envelope.

Removable skin technology ensures that if there is a future need for updating the exterior, those panels can be changed without interrupting ongoing building operations. The flexibility to replace individual panels, rather than the entire system, adds another level of dimensionality to a system that is already extremely versatile.

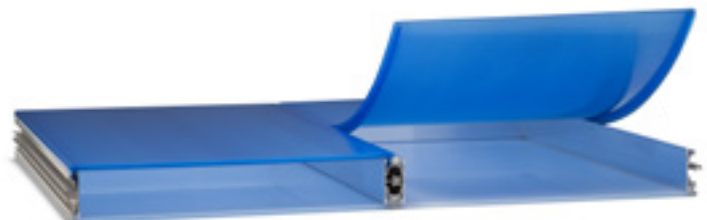

## Multi-Color Panel Option

A different color can be selected for each of the two independent glazing panels that make up the system. As a designer, you may want to make a bold statement by using colorful panels on the exterior and utilize a neutral panel color on the interior for a clean, finished look.

While glazing color combinations offer an opportunity for creativity, they also serve a practical purpose when tailoring the performance of the system. Each glazing color has an inherent solar performance. By varying the combination of the glazing colors, not only can you create unique visual elements, but you can also customize the solar performance of the system. The optional matte finish on the panels will increase their ability to diffuse light and eliminate glare.



## Longer Clear Spans

Due to the design of the internal support structure, the panel system can achieve longer spans and still comply with deflection and code requirements. The ability to span floor-to-slab minimizes the necessary support structures – reducing the cost of material and labor. It also improves the aesthetic quality of the system.

## Nano-Cell® Glazing



Our patented Pentaglas® translucent glazing is precision engineered with Nano-Cell® technology. This specialized panel extrusion results in the cells measuring smaller than 0.18 inches, and provides the panel with increased durability and prolonged resistance to impact. The unique cell structure also significantly improves the quality and even distribution of glare-free natural light.



One trusted system  
Infinite possibilities

What's your next bright idea?



▲ Project: Akron Children's Hospital Parking Garage  
ID: 35531  
Location: Akron, OH  
Architect: GPD Group

### Specialized Performance Options

We understand that due to budget, occupancy, and building type, not all building envelopes are made equal. That is why we designed a system with an internal cavity that can be modified with additional inserts to meet the performance requirements of any building. Whether you need a system that can dynamically manage light levels in a classroom, meet forced entry standards for a military facility, or anything in between, we can help you achieve your performance goals.



Dynamic Shading System

- Dynamic Shading System
- Additional Insulation
- LED Lighting
- Sound Reduction (STC)
- Forced Entry Resistance
- Perforated Metal Insert



Military Facility per DoD Standards





▲ Project: Coquille Community Center  
ID:31260  
Location: Covington, LA  
Architect: Holly & Smith Architects

## LED Lighting

With the integration of LED lighting, the daylighting system is transformed into an elegant night-lighting feature. With the flip of a switch, your building becomes a beacon of creativity.



## Graphics

Graphics can be used to create an iconic look or to reinforce a building owner's brand through signage, logos, etc. Add textures, geometric patterns, or other unique visual elements to either the system's interior or exterior, and produce different effects that are sure to make your building standout.



# UniQuad® | Translucent Walls

Design + Engineer + Manufacture

The hallmark of the UniQuad® system is the innovative two-piece panel connection, which enables the system to be unitized. The panels themselves are factory glazed and assembled for superior quality control. The unitized construction of the system results in quick, cost-effective installation.

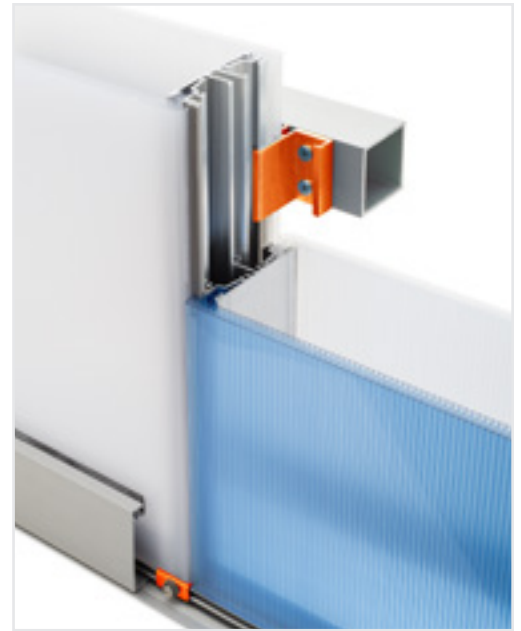
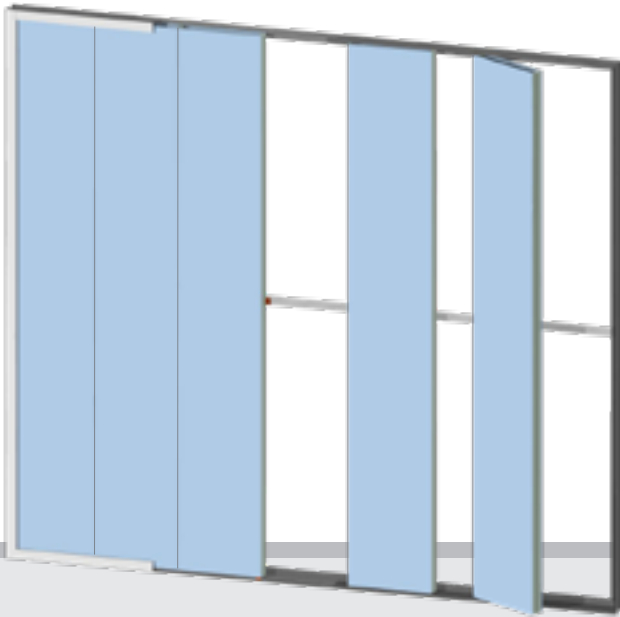

## Our Innovative Technology



### Frame System

The two-piece frame system consists of a sill and sub-sill. It is designed so that the necessary fasteners don't penetrate the sill frame. A thermally broken frame is also available.



### UniClip™

The concealed UniClip™ is designed as a structural clip, capable of withstanding heavy loads. The specialized design enables the panels to be installed quickly and remain in place without needing frame caps.



### Panel Clip

The panel clip fastens directly to the internal UniQuad® structure, which prevents the glazing from breaking under extreme clip loads, as is common with other systems. The metal-to-metal connection enables the glazing to freely expand and contract. It also increases the system's ability to withstand high loads and span floor-to-slab.





1

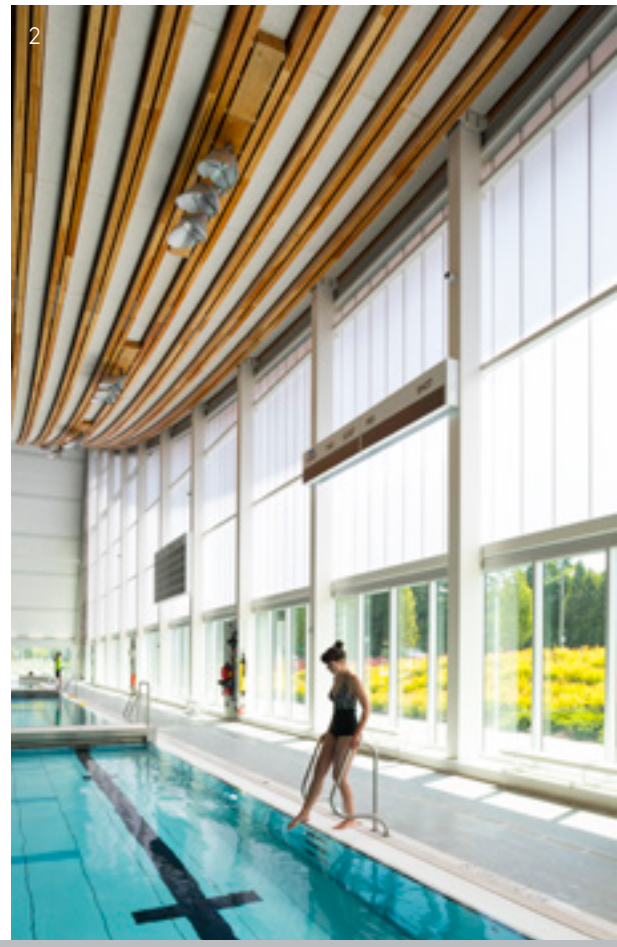

2



3

- ▲ 1 Eagle Academy ID: 35107
- 2 Grandview Heights Aquatic Centre ID: 36690
- 3 Virtua Health & Wellness Center ID: 23637

### Product Specifications

Thickness:	4.25 in (108 mm) & 3 in (76 mm)
Width:	2 ft nominal (23.75 in) (603 mm)
Length:	Up to 44 ft long
Panel Weight:	1.5-2 lbs/ft <sup>2</sup>
Technology:	Removable Skin Technology (RST) - Allows for the removal of the exterior panel while the interior panel remains in place
Panel Joint:	Structural member, mechanically interlocking, sealed joint
Exterior Skin:	10 mm Pentaglas® translucent panel with Nano-Cell® extrusion
Interior Skin:	10 mm Pentaglas® translucent panel with Nano-Cell® extrusion
Color Options:	Standard - Clear matte, white matte, ice white matte, blue matte, green matte Consult KLA for other available color options, including bronze matte, gray matte, white pearl low-E, and other exotic colors Note: all colors are available with a non-matte finish upon request
Bi-Color System:	Option to select one color for the exterior glazing panel, and a different color for the interior glazing panel

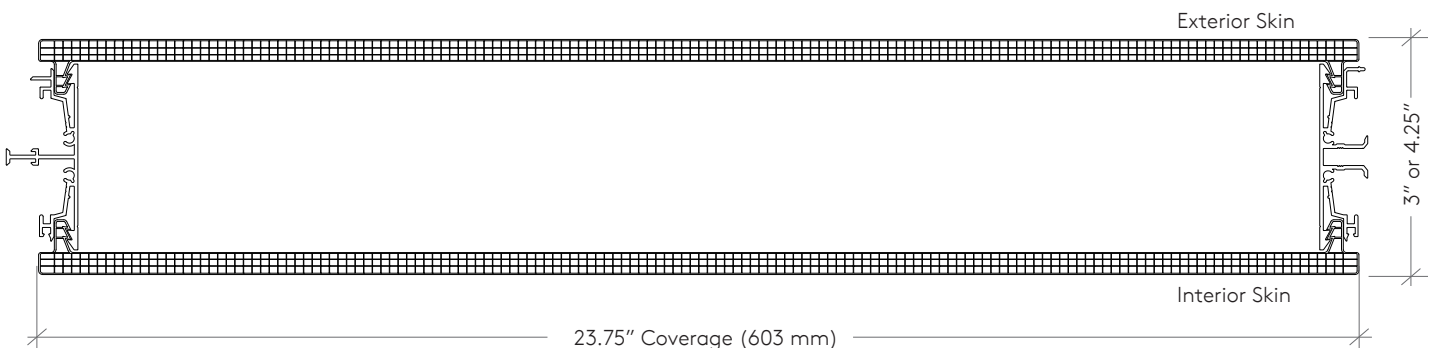

# UniQuad® | Translucent Walls

## Design + Engineer + Manufacture

The extreme versatility and unitized assembly of the UniQuad® system makes it the perfect system for walls and building facades. This system is also effective for clerestories and smaller scale punched openings.

UniQuad's sleek, linear aesthetic and modular construction enable the system to be easily integrated with other building envelope components.

With a wide range of colors, and the potential for incorporating graphics and lighting, UniQuad offers designers the opportunity to rethink daylighting in a creative and inspiring way.

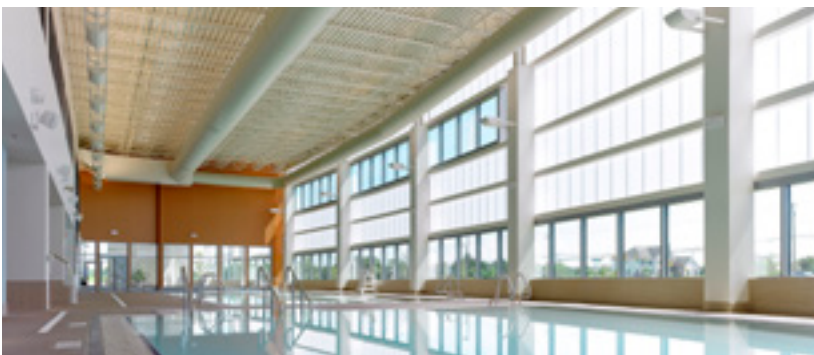

- ▲ 1 AVCRAD Facility ID: 29452
- 2 Eagle Academy ID: 35107
- 3 Maryland Heights Community Center ID: 39535

## Large Scale Facades

Individual panels can be manufactured up to 44 ft. tall and are able to span across floors of multi-level buildings. Panels can clear span floor-to-slab, depending on the height and loading conditions.

- ◀ Project: Richmond Olympic Oval  
ID: 20460  
Location: Richmond, BC  
Architect: Cannon Design

## Daylighting Zones

Manage the level of transparency to create focal points and control views. Integrate a translucent system to maximize light while minimizing heat gain and glare.

- ◀ Project: Virtua Health & Wellness Center  
ID: 23637  
Location: Washington Township, NJ  
Architect: HGA

# A Better, Brighter Building Envelope



▲ Project: Austin ISD Performing Arts Center  
ID: 35165  
Location: Austin, TX  
Architect: Pfluger Architects & Miró Rivera Architects



## Pentaglas® | Cladding

Our Pentaglas® system can be used for cladding structures that enclose non-conditioned spaces.

Our cladding system can help you achieve a variety of goals:

- Modernize the exterior of a building
- Meet hurricane standards
- Create an area for signage
- Backlighting

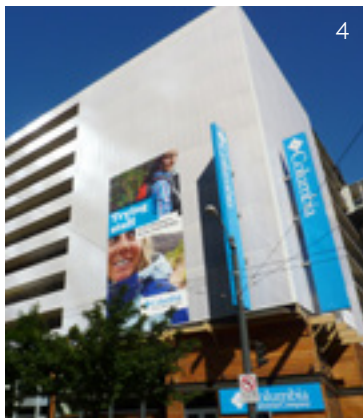

◀ 1 Spoke Apt Complex ID: 42858  
2 Mission Creek Kayak Storage ID: 24532  
3 Sarasota Police Station ID: 25772  
4 3rd & Pine Parking Garage ID: 22125

# Quadwall® | Skylights

Design + Engineer + Manufacture

Kingspan Light + Air | CPI Daylighting utilizes the latest in daylighting technology to provide the market with efficient and effective solutions to meet their daylighting needs and enhance the environments where we work, learn, play and live.

We offer a wide variety of skylight options - ranging in scale from small and simple to monumental and complex. These skylights are available in a variety of standard shapes, including vaults, ridges, single slopes, pyramids, polygons, and domes. We also work with architects and designers to develop custom skylight systems.

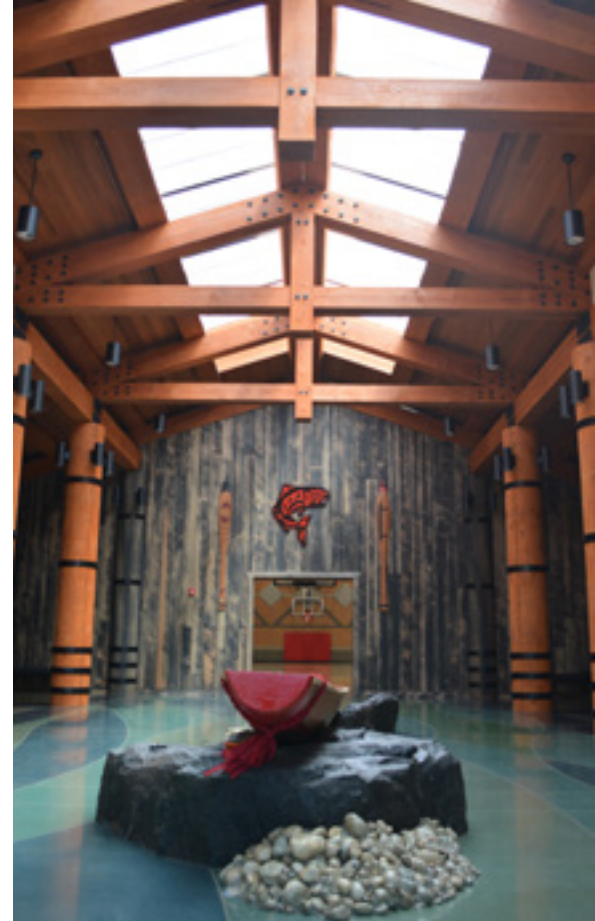

“ Not only do we now have more light in our atrium, along with watertight integrity, but we have strengthened our relationship with employees and customers by providing an environment in which they can thrive.

- Pete Flood | Construction project manager, SAS

- ▲ Project: Stillaguamish Community Center  
ID: 38391  
Location: Arlington, WA  
Architect: Womer and Associates
- ▶ Project: Bogan Park Aquatic Center  
ID: 33261  
Location: Buford, GA  
Architect: Wright & Mitchell Architects



Skylights over atriums and large common spaces are an impactful design feature that can make a space more inviting and create an open and comfortable environment for occupants.

- ◀◀ Project: Hologic, Inc.  
ID: 34563  
Location: San Diego, CA  
Architect: Smith Group Consulting
- ◀ Project: Bloomingdale's at Beverly Center  
ID: 35264  
Location: Los Angeles, CA
- ▶ 1 Allen High School ID: 42976  
2 University of Oregon Student Rec ID: 36496  
3 Mall Del Norte ID: 23445

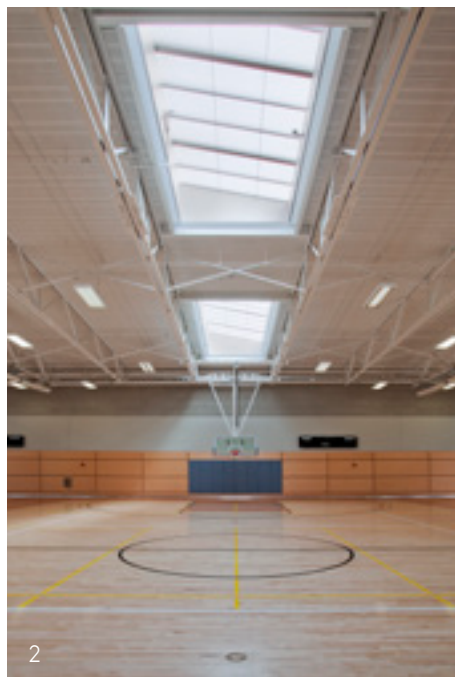

# BriteWay™ | Canopies

Design + Engineer + Manufacture

Kingspan Light + Air | CPI Daylighting is a single source provider of BriteWay™ translucent canopies, offering flexible design options that include both pre-engineered and customized systems from the ground up.

Our canopies utilize patented Pentaglas® translucent glazing, which is precision engineered and extruded to have a Nano-Cell® configuration. This unique glazing extrusion results in superior durability and produces a more even distribution of glare-free natural light into adjacent spaces that would otherwise be cast in shadow.

Pentaglas is designed as a standing seam system that utilizes an interlocking mechanical connection. The innovative double-toothed edge on the up-stands of the panels enables this system to withstand extremely high loads. Systems designed and certified for hurricane resistance are also available.

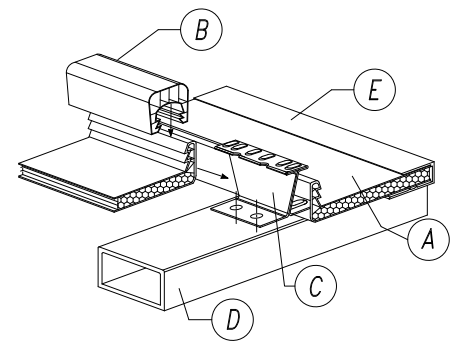

- A** Pentaglas® glazing panel
- B** Double-toothed panel connector
- C** Stainless steel panel clip
- D** Aluminum purlin substructure
- E** Aluminum framing system



◀ Project Tanger Outlet Mall  
 ID: 36369  
 Location Oxon Hill, MD  
 Architect Adams + Associates Architecture

◀ Project Monrovia Station Square  
 ID: 40160  
 Location Monrovia, CA  
 Architect IBI Group



## Clearspan Canopies ▶

The innovative clearspan design eliminates the need for cross-bracing, which opens up the space below the canopy structure. Our clearspan canopies are pre-engineered based on specific design criteria, and are an economical solution that provides shelter while also allowing natural light into adjacent spaces. The rust-free aluminum structure offers excellent durability and system longevity.



▲ Project Norwalk Hospital  
ID: 32016  
Location Norwalk, CT  
Architect Freeman White

▲ Project CTA - Cermak Green Line Station  
ID: 37707  
Location Chicago, IL  
Architect Ross Barney Architects

- ▼ 1 Metropolitan MSC ID: 40892
- 2 Kaiser Town Park Community Medical Center ID: 3356
- 3 USCB Recreation Center ID: 38857
- 4 Moanalua Shopping Center ID: 20809

“The versatility of the Pentaglas® canopy and framing system allowed us to get creative with the concept.”

— Christopher Souza | Architect, AECOM



### ◀ U-Lite

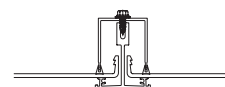

Monolithic standing seam panel system for low slope canopy applications

- High-impact resistant
- Long span capabilities
- Exposed edge design



### ◀ LiteBrow

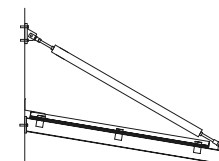

Suspended translucent canopy system

- Highly durable (designed for +/- 120 psf combined loads)
- Economical modular system (Standard sizes: 4 ft, 8 ft & 12 ft)
- Custom design options available

# IntelaSun® - Dynamic shading system

Design + Engineer + Manufacture

IntelaSun® is a dynamic shading system that adjusts based on the angle of the sun and user-controlled settings. IntelaSun effectively balances light-levels and eliminates solar heat gain and glare throughout the day. This dynamic system improves building efficiency by lowering peak loads and utility costs, and creates a comfortable environment for occupants. IntelaSun - the perfect solution for all your high-performance daylighting needs.

## SolaBlades®

The key to IntelaSun's success is the series of rotating internal louvers, called SolaBlades®. The SolaBlades optimize building performance by regulating the amount of sunlight, solar heat gain and shading within a given space. With the ability to rotate a full 360 degrees, the blades gradually adjust their angle throughout the day to deliver and maintain the desired amount of light. With a system that adapts to harvest daylight when the sun is at a low angle and shade the space during peak sunlight hours, you are no longer limited to designing a system for a single daylighting scenario.



## SolaBlade® Sun Tracking

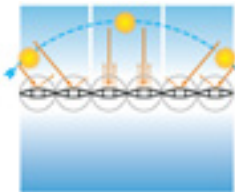

Minimum light transmission and solar heat gain

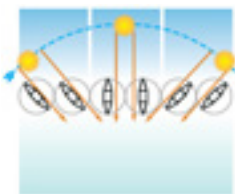

Maximum light transmission regardless of sun angle

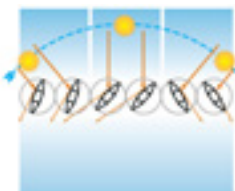

Blades are angled to diffuse light transmission to suit user preferences

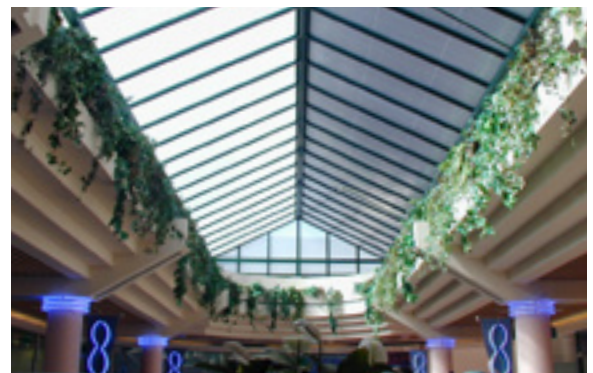

▲ Project: San Benito High School  
ID: 40711  
Location: Hollister, CA  
Architect: Aedis Architects



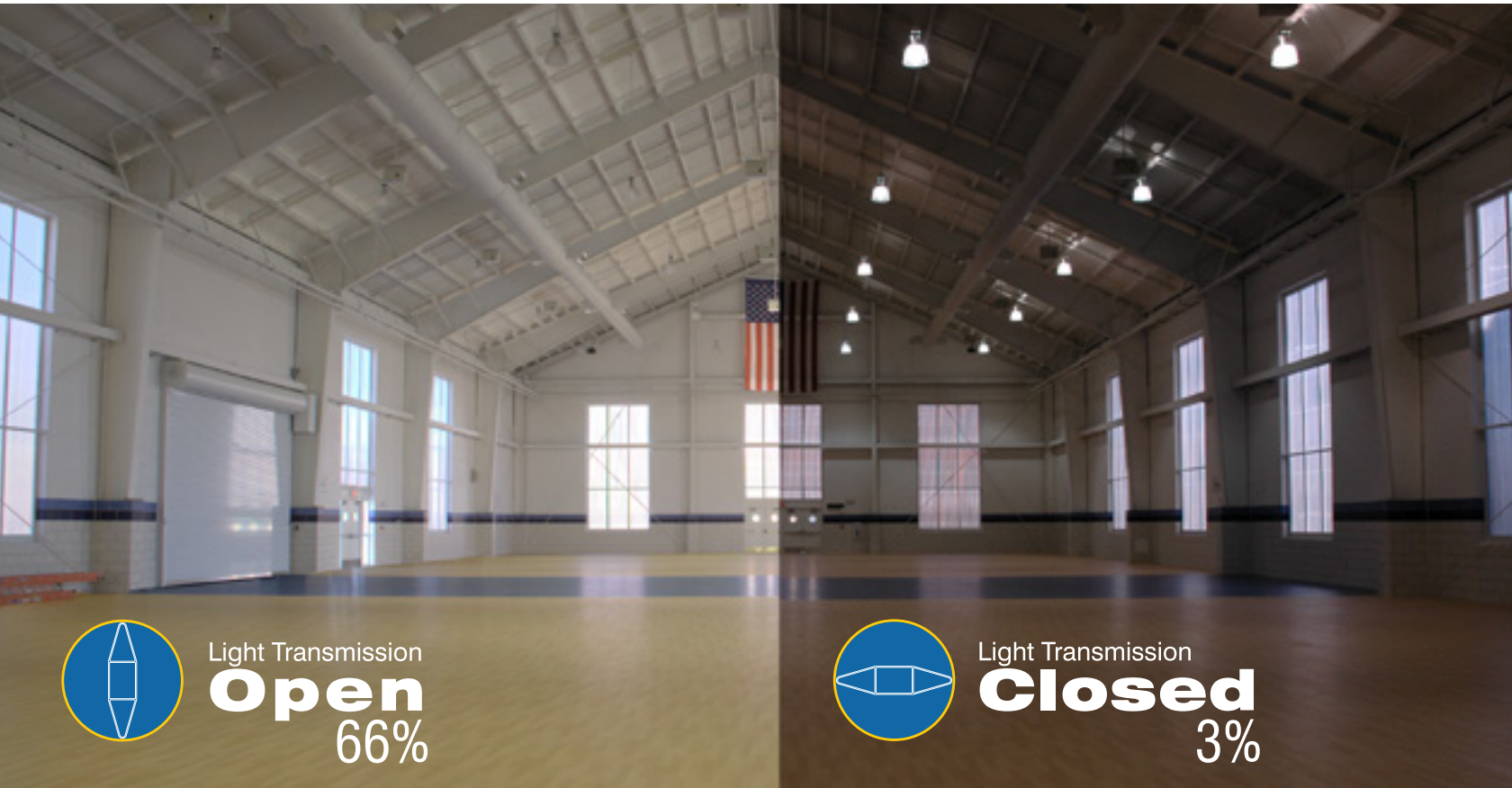

Light Transmission  
**Open**  
 66%



Light Transmission  
**Closed**  
 3%

▲ Project: Great Lakes Naval Training Facility  
 ID: 20405  
 Location: Great Lakes, IL  
 Architect: Wight & Company

## Dynamic Daylighting

Sensors on the exterior and interior of the building enable the system to track the sun and adjust to maintain optimal light levels throughout the day. The system can be programmed to be fully automated or operated manually from a wall-mounted control. When completely open, the system achieves a light transmission of sixty-six percent, while closing the blades will reduce the light transmission to a mere three percent.



▲ Project: University of Oregon Student Rec  
 ID: 36496  
 Location: Eugene, OR  
 Architect: Robertson Sherwood Architects & RDG  
 Planning Group



▲ Project: da Vinci Arts Middle School  
 ID: 26248  
 Location: Portland, OR  
 Architect: SRG Partnership

# Retrofits & Renovations

Design + Engineer + Manufacture

## Why Renovate?

- Outdated or degenerating systems are underperforming
- Discoloration has resulted in a significant decrease in light levels
- Deterioration is causing leaks and potential structural failures

We offer a variety of simple and effective turn-key retrofit and renovation solutions designed to reglaze, over-glaze or replace existing systems that are underperforming or are in desperate need of repair due to damage or deterioration.

Our two-panel system ensures that your building envelope is not compromised in the future, as the interior panels will be able to remain intact indefinitely.

Skylight retrofits and renovations can play a key role in revitalizing environments that are suffering from lack of adequate natural lighting.

Deteriorating skylights often block out blue spectrum light, which accounts for the majority of health benefits associated with natural light.

## We Renovate...

- Glass
- Fiberglass
- Acrylic
- Polycarbonate



## Reglaze

The glazing system will be replaced and the existing structure will be evaluated and reused when possible.

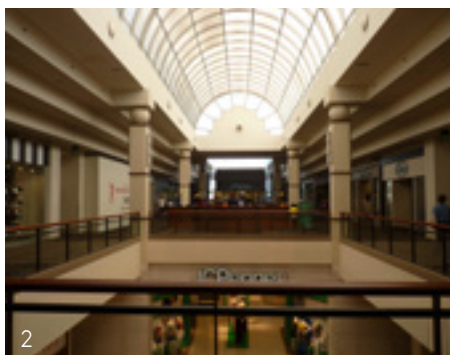

## Overglaze

Pentaglas® systems can be designed to envelop leaking systems if their performance is otherwise uncompromised. This option is typical for systems that provide enough light, but may be deteriorating, leaking or need additional insulation performance.

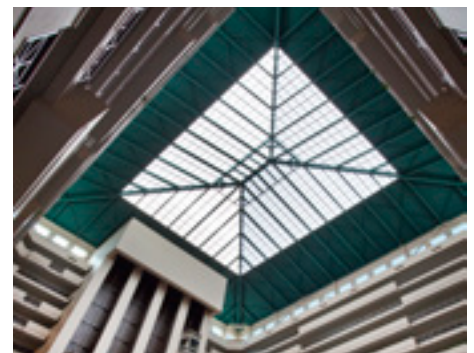
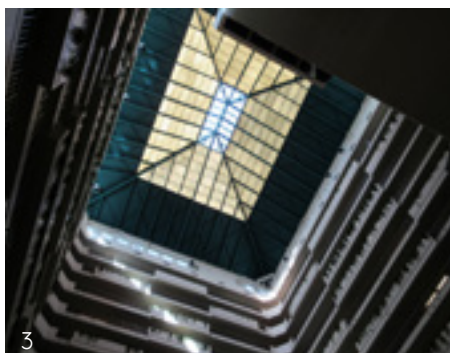

## Replace

The entire existing system is disassembled and removed and a new system will be installed in its place.

Before

After



Before



After

▲ Project: Pembroke Lakes Mall  
ID: 39972  
Location: Pembroke Pines, FL

- ◀ 1 Lakewood Mall ID: 39224
- 2 Town Center at Cobb ID: 27224
- 3 Embassy Suites ID: 34534

“ The difference in the lighting in the hallway and the gym is dramatic. We rarely need to use the lights in the hall because there is so much natural light. ”

–John Grote | Executive Director, Northside Community School

▼ Project: Raleigh Memorial Auditorium  
ID: 36730  
Location: Raleigh, NC  
Architect: REI Engineers

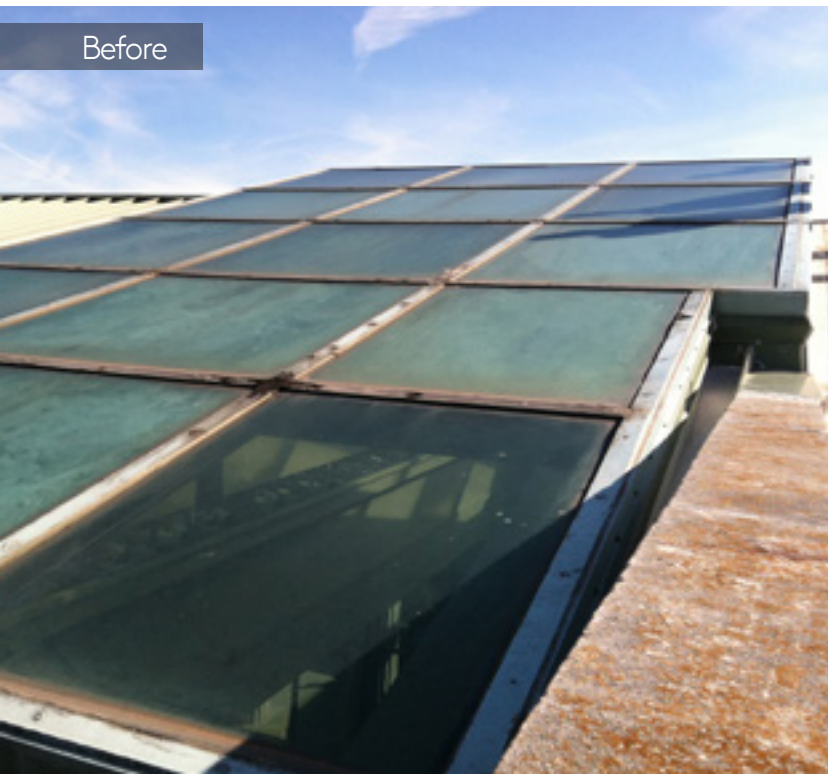

Before



After

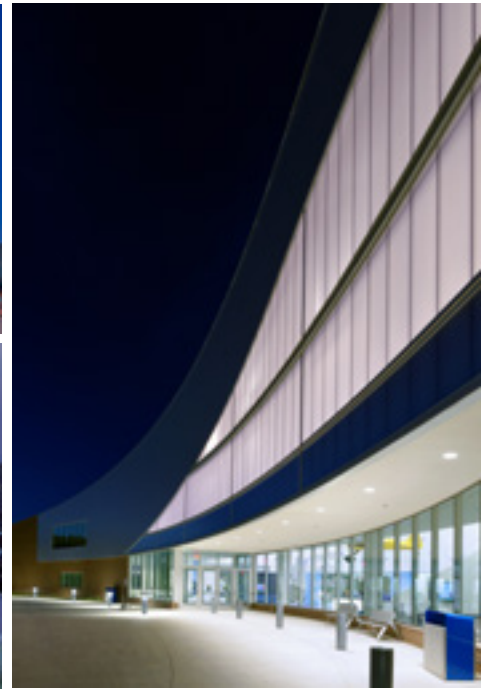

To learn more, visit:

[www.cpidaylighting.com](http://www.cpidaylighting.com)  
[www.kingspanlightandair.us](http://www.kingspanlightandair.us)

© 2019 Kingspan Light + Air | CPI Daylighting, Inc. All rights reserved.

Kingspan Light + Air | CPI Daylighting reserves the right to change, discontinue or modify our products, specifications and designs at any time without notice and without incurring obligations. - Printed in the U.S.A.

Kingspan Light + Air | CPI Daylighting

28662 N. Ballard Dr.  
Lake Forest, IL 60045 U.S.A

800.759.6985 847.816.1060  
Fax 847.816.0425

